

525 SERIES  
DUAL PANE WITH 1 SHG FILM  
ARGON GAS FILL

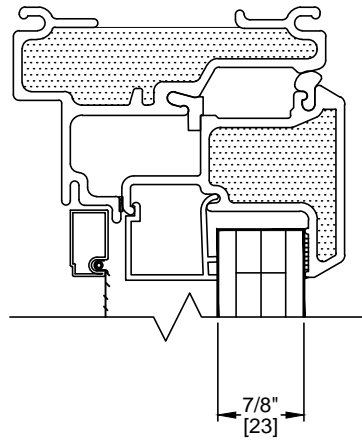

725 SERIES  
DUAL PANE WITH 1 SHG FILM  
KRYPTON GAS FILL

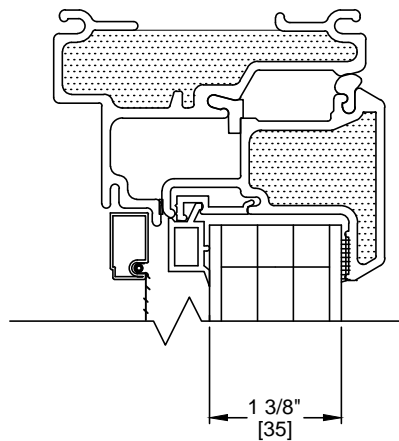

925 SERIES  
DUAL PANE WITH 2 SHG FILM  
KRYPTON GAS FILL

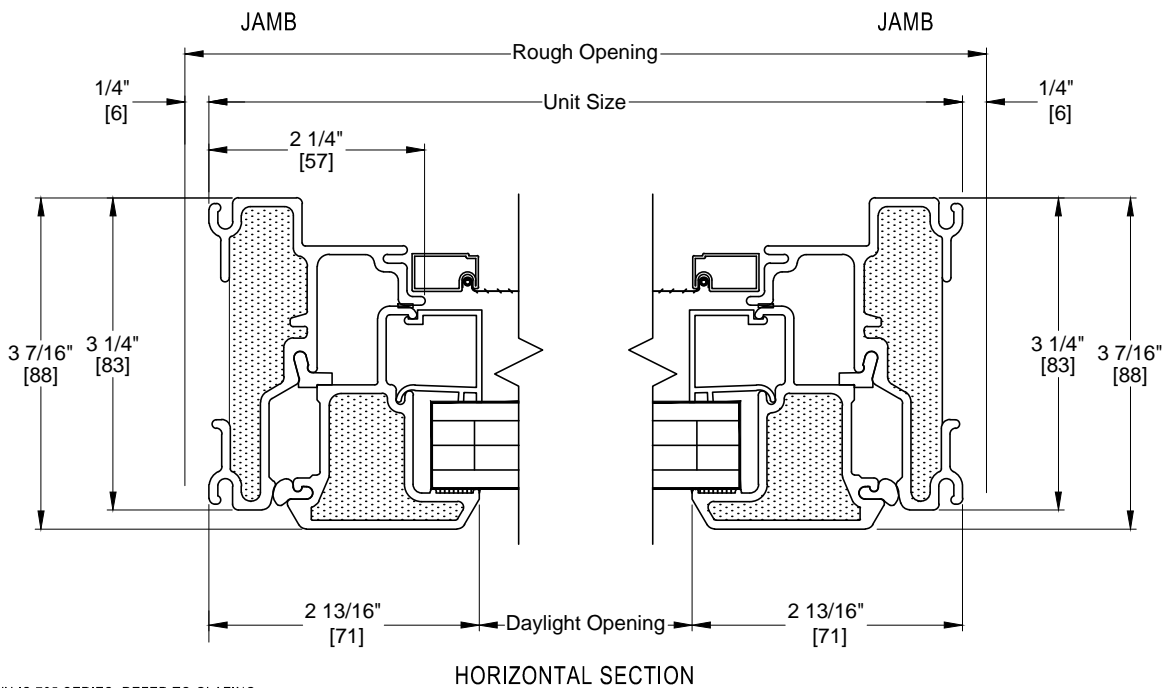
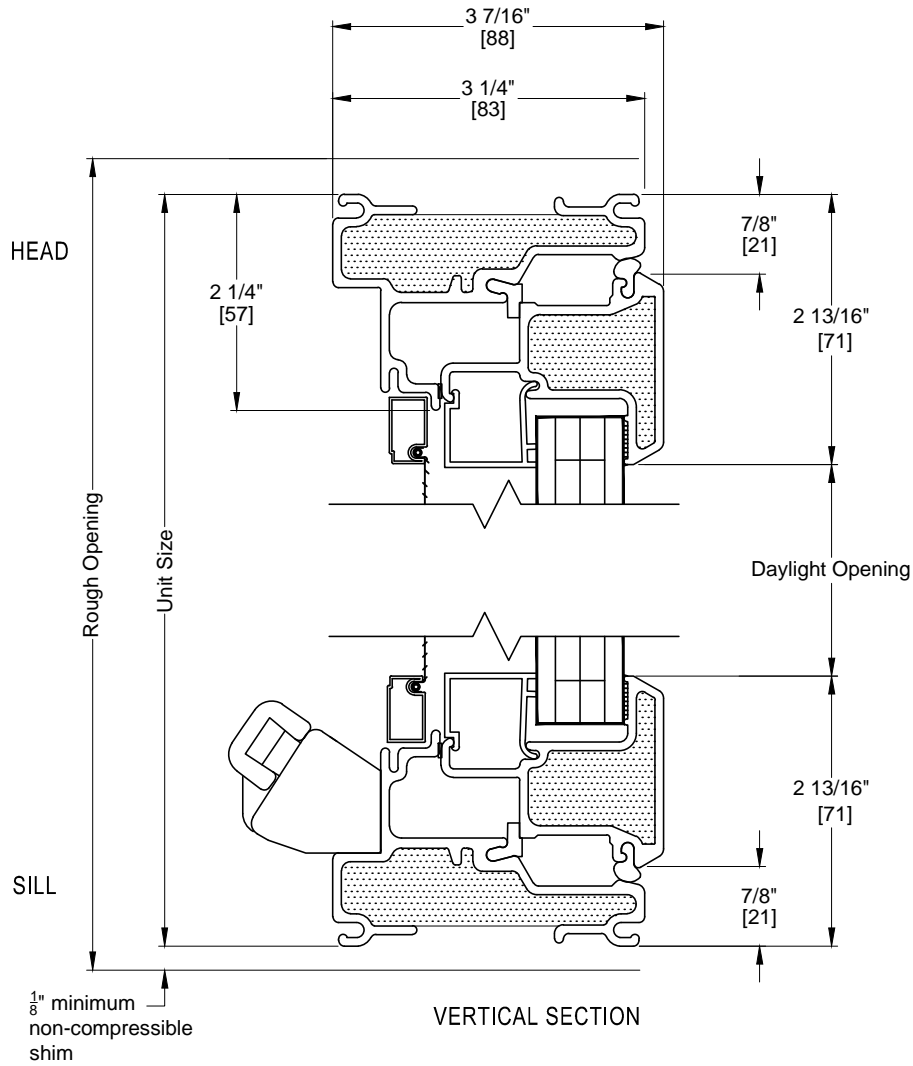

GLAZING SHOWN IS 725 SERIES, REFER TO GLAZING OPTIONS FOR SERIES SPECIFIC GLAZING DETAILS.

WINDOW DETAILS: NON INTEGRAL ALUMINUM NAIL FIN

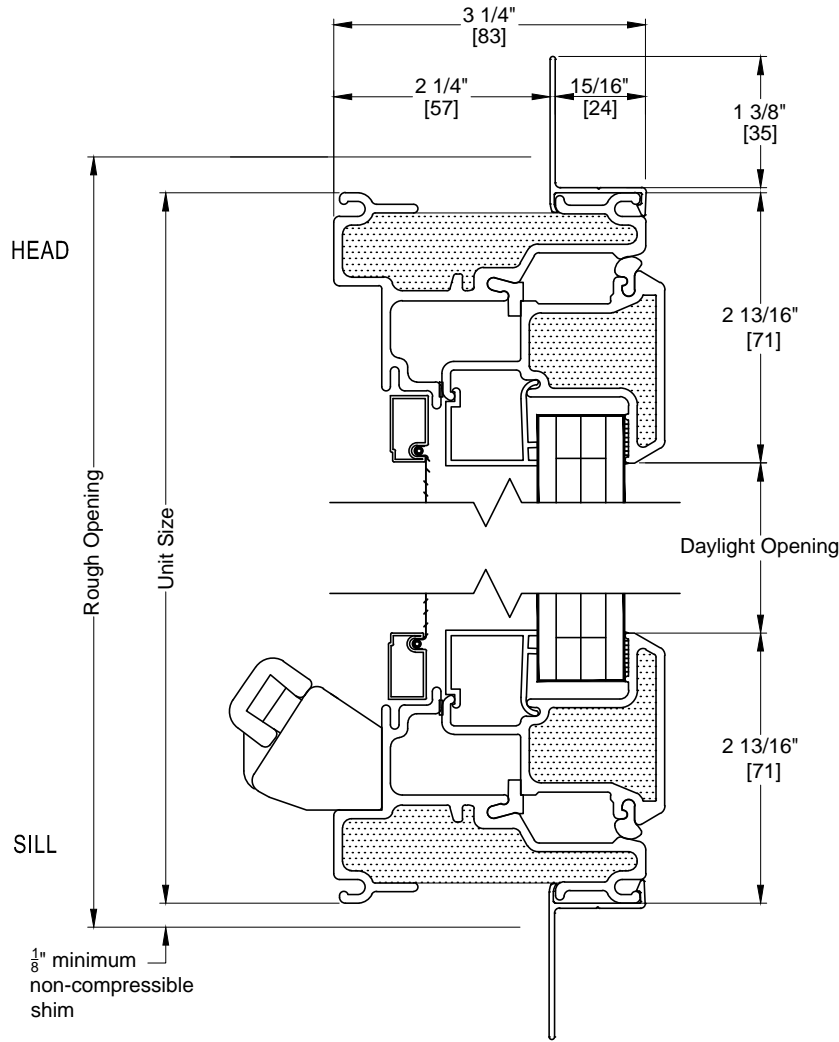

VERTICAL SECTION

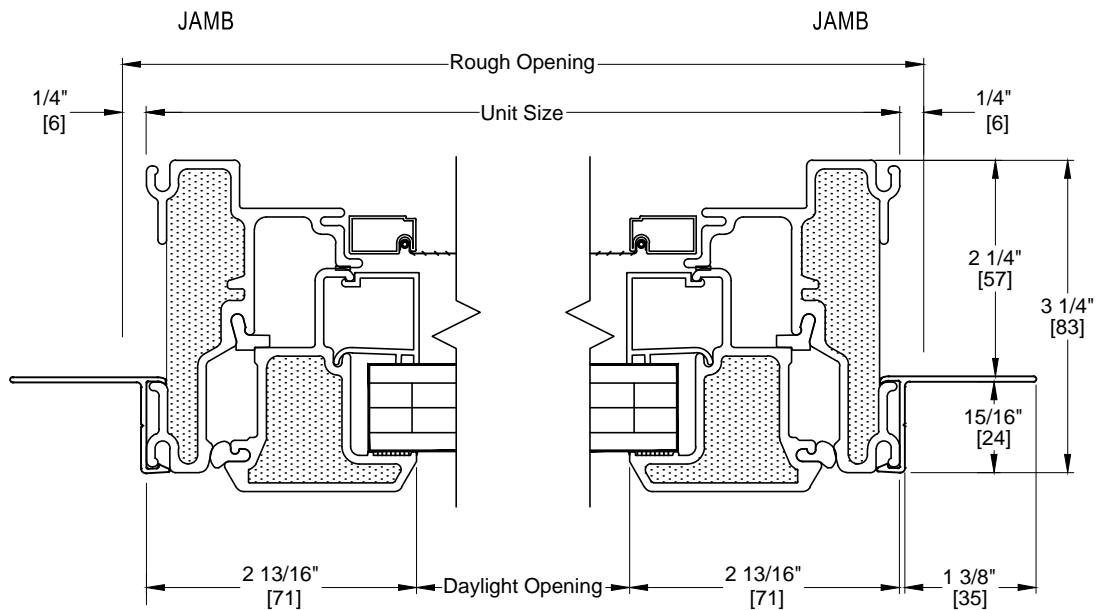

HORIZONTAL SECTION

GLAZING SHOWN IS 725 SERIES, REFER TO GLAZING OPTIONS FOR SERIES SPECIFIC GLAZING DETAILS.

WINDOW DETAILS: FIELD APPLIED ANCHOR STRAPS

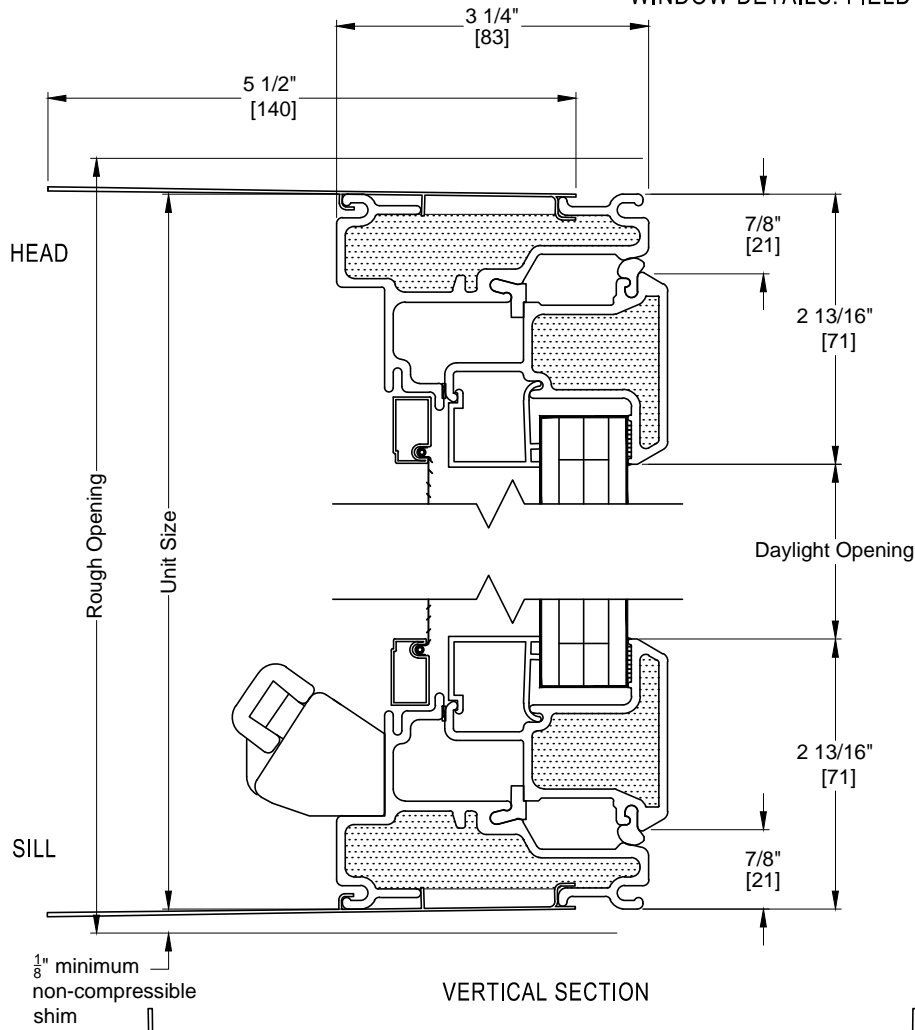

VERTICAL SECTION

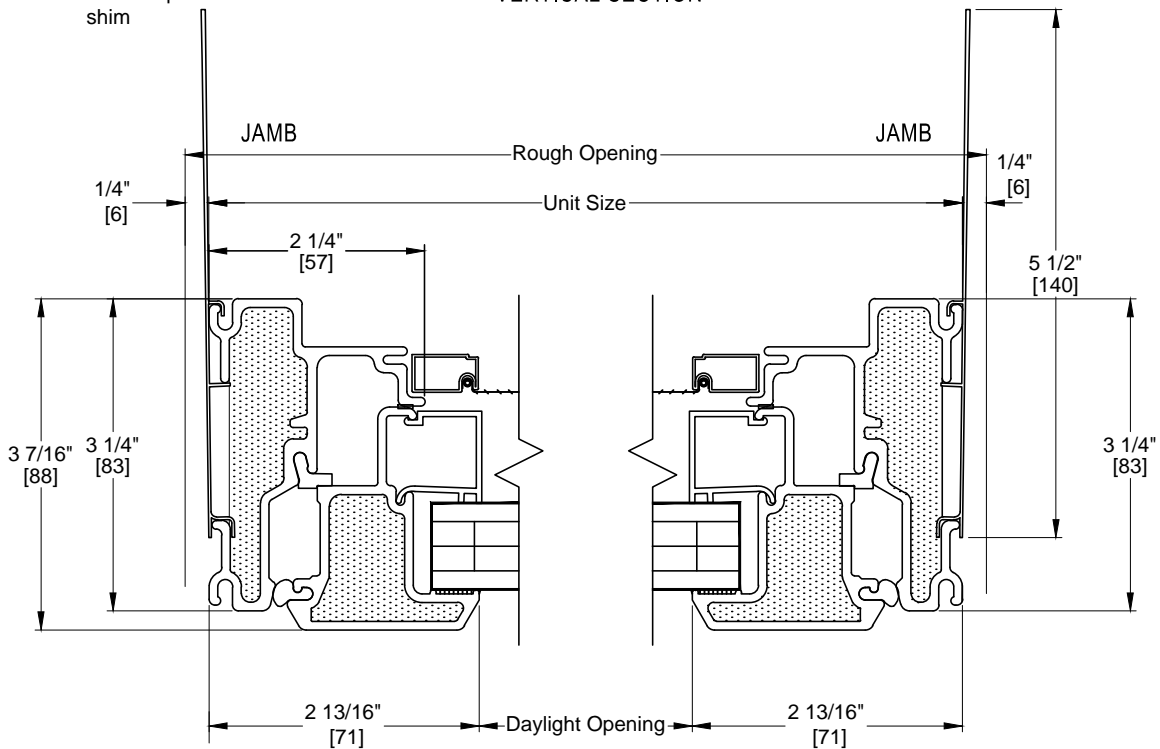

HORIZONTAL SECTION

GLAZING SHOWN IS 725 SERIES, REFER TO GLAZING OPTIONS FOR SERIES SPECIFIC GLAZING DETAILS.

WINDOW DETAILS: ALUMINUM BRICKMOULD WITH FIN

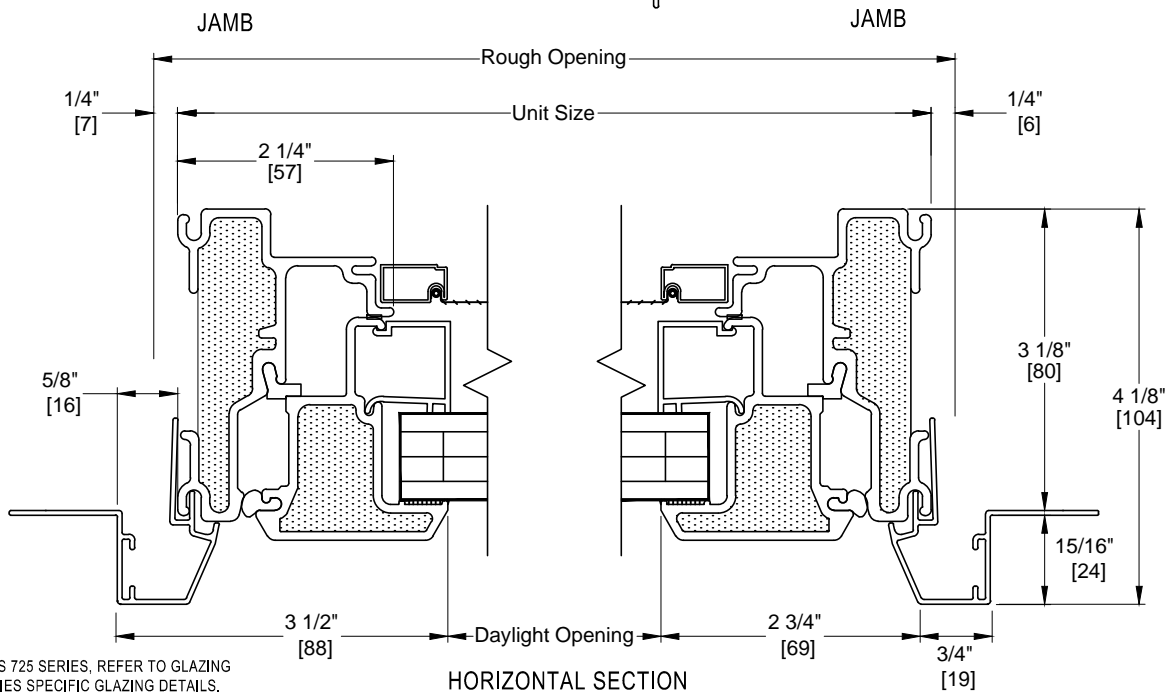
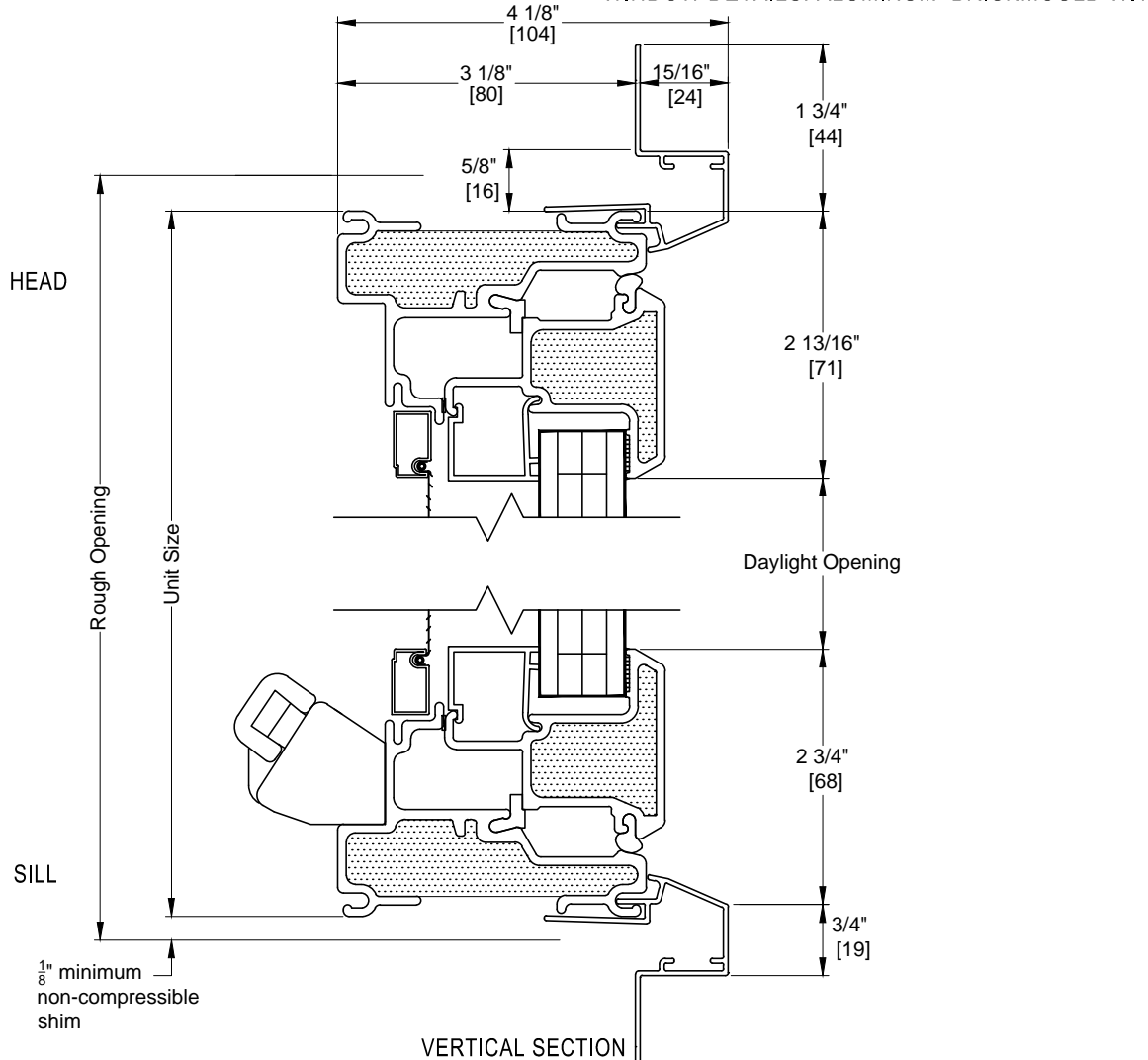

GLAZING SHOWN IS 725 SERIES, REFER TO GLAZING OPTIONS FOR SERIES SPECIFIC GLAZING DETAILS.

WINDOW DETAILS: ALUMINUM BRICKMOULD WITHOUT FIN

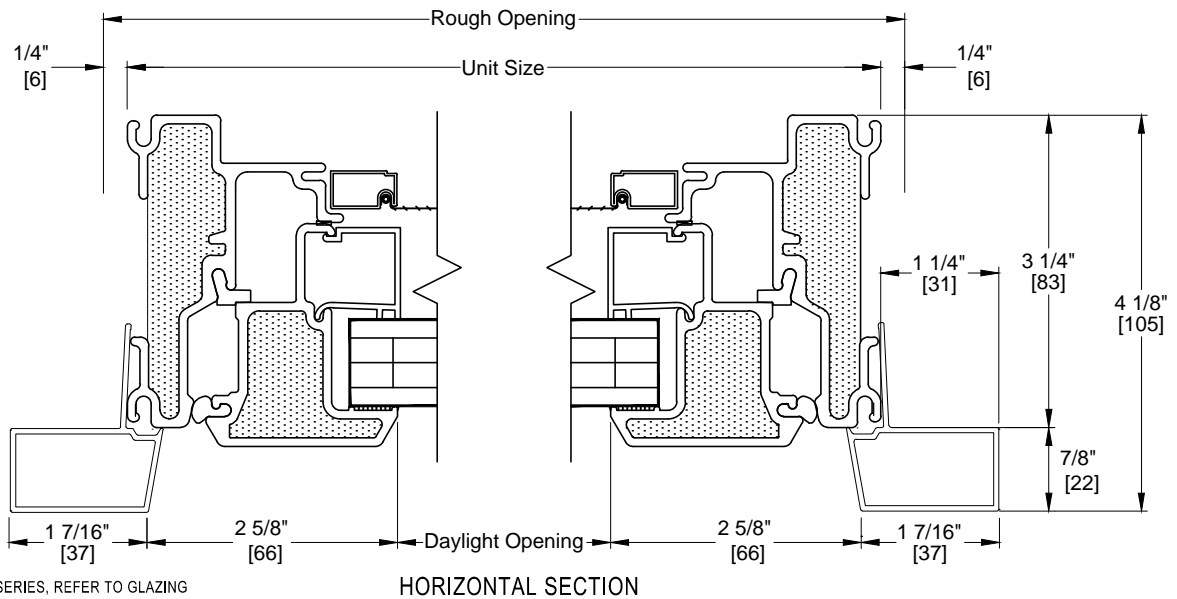
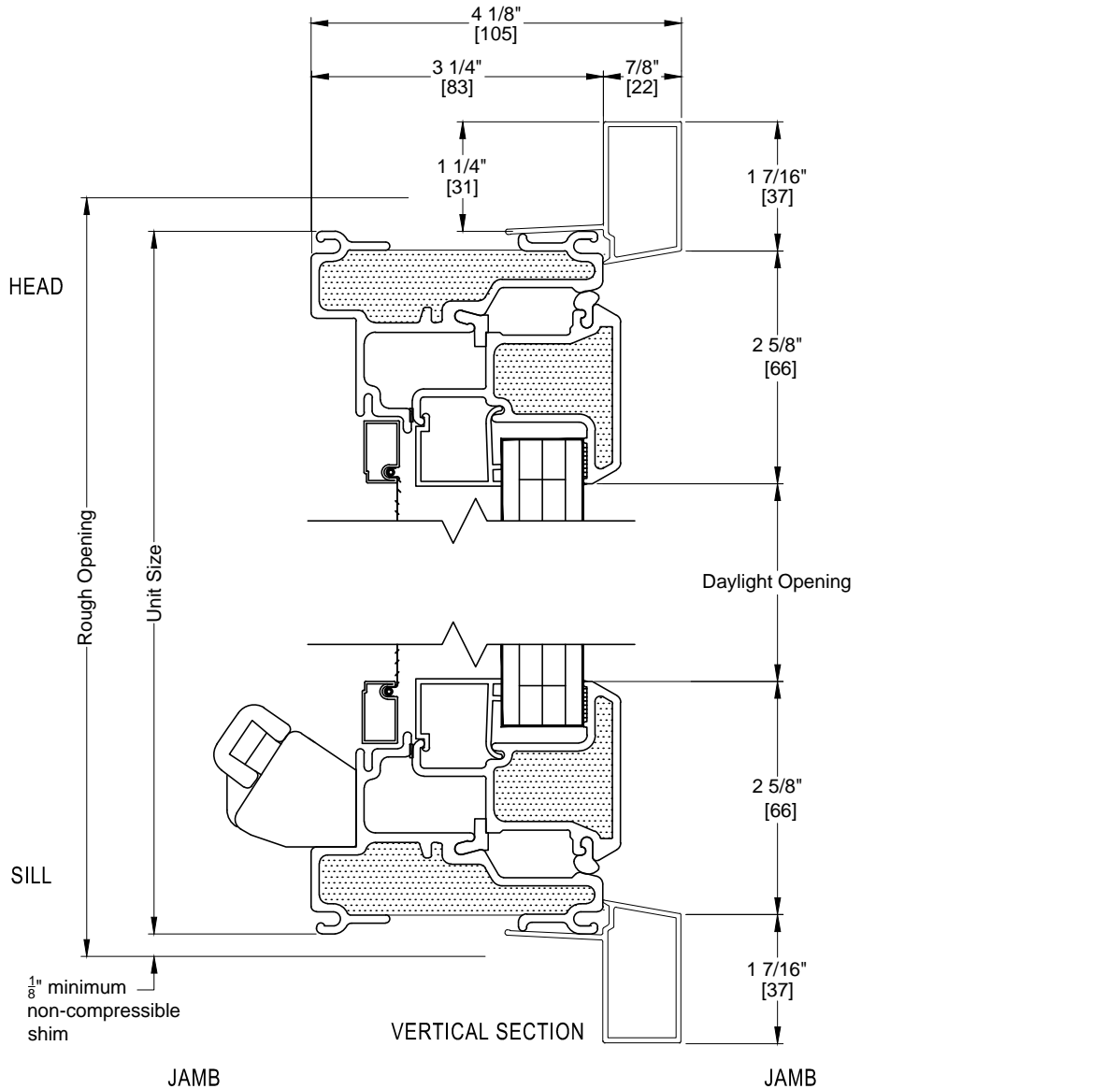

GLAZING SHOWN IS 725 SERIES, REFER TO GLAZING OPTIONS FOR SERIES SPECIFIC GLAZING DETAILS.

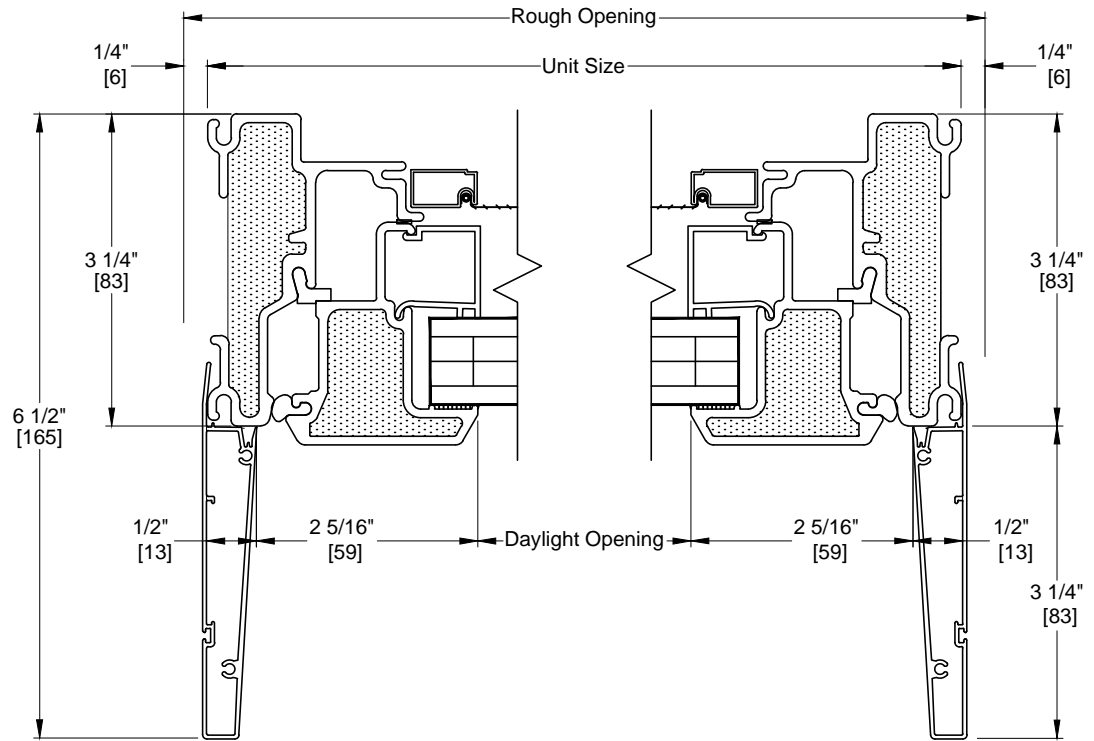
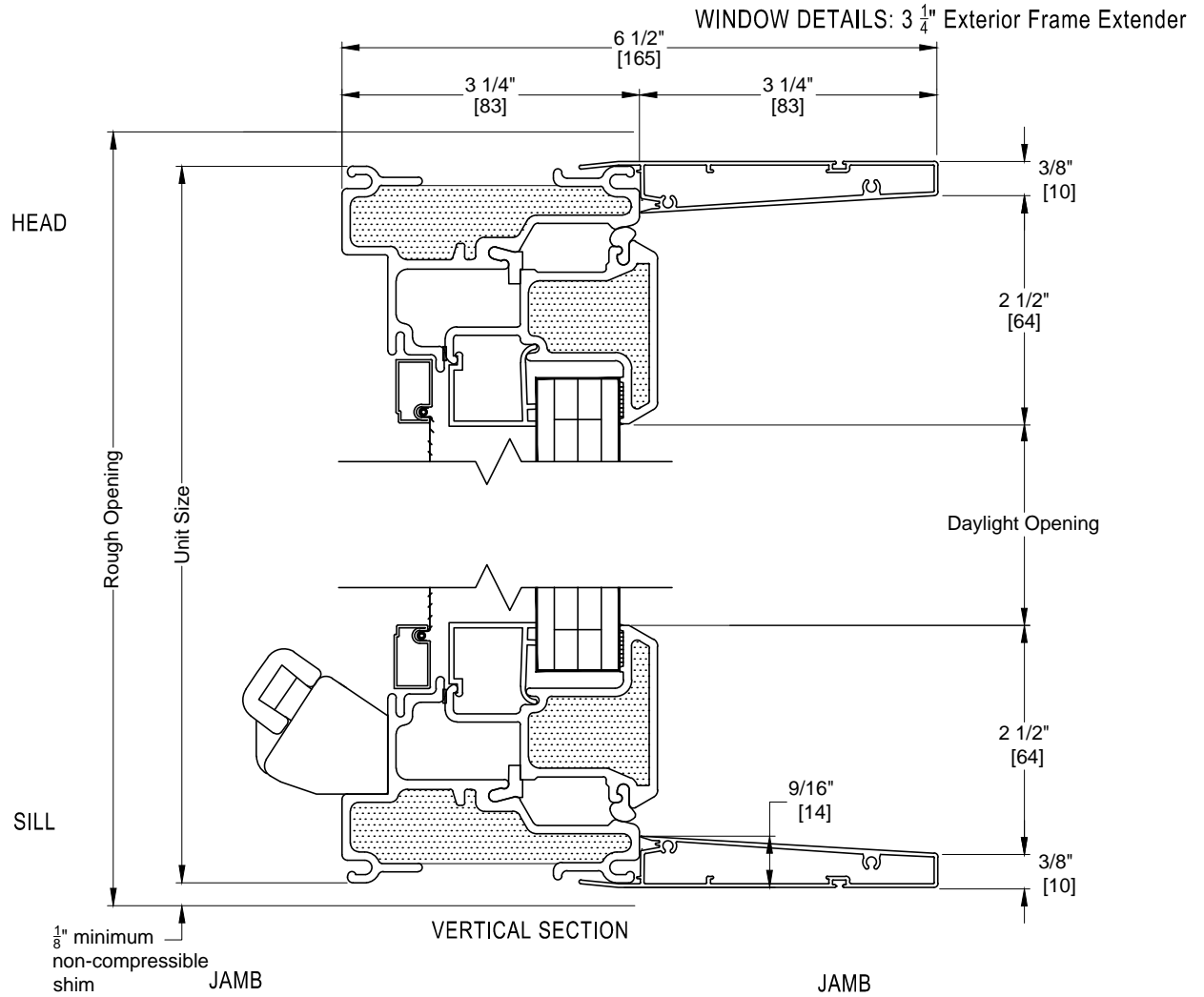

GLAZING SHOWN IS 725 SERIES, REFER TO GLAZING OPTIONS FOR SERIES SPECIFIC GLAZING DETAILS.